

OVEN SPECS OVERVIEW

External Measurements

External width: 950mm
External depth: 1050mm
External height: ≈600mm

Internal Measurements

Internal width: 720mm
Internal depth: 860mm
Internal height: 400mm

Door/Mouth Measurements

Width: 530mm
Height: 270mm

Stainless Steel Flue Measurements

Length: 1000mm
Diameter: 6" (approx 152mm)

Weight

Completed unit (including slab) ≈550kg
DIY kit (no slab) ≈400kg

BASE CONSTRUCTION COURTYARD MODEL

Slab dimensions for completed oven – 950mm wide x 1050mm deep x 65mm thick*

*Slab is provided with completed ovens only. If making your own slab we recommend 100mm reinforced concrete.

NOTE Bench and wall heights are a guide only – you can build your base to whatever height will be most comfortable for you when using the oven.

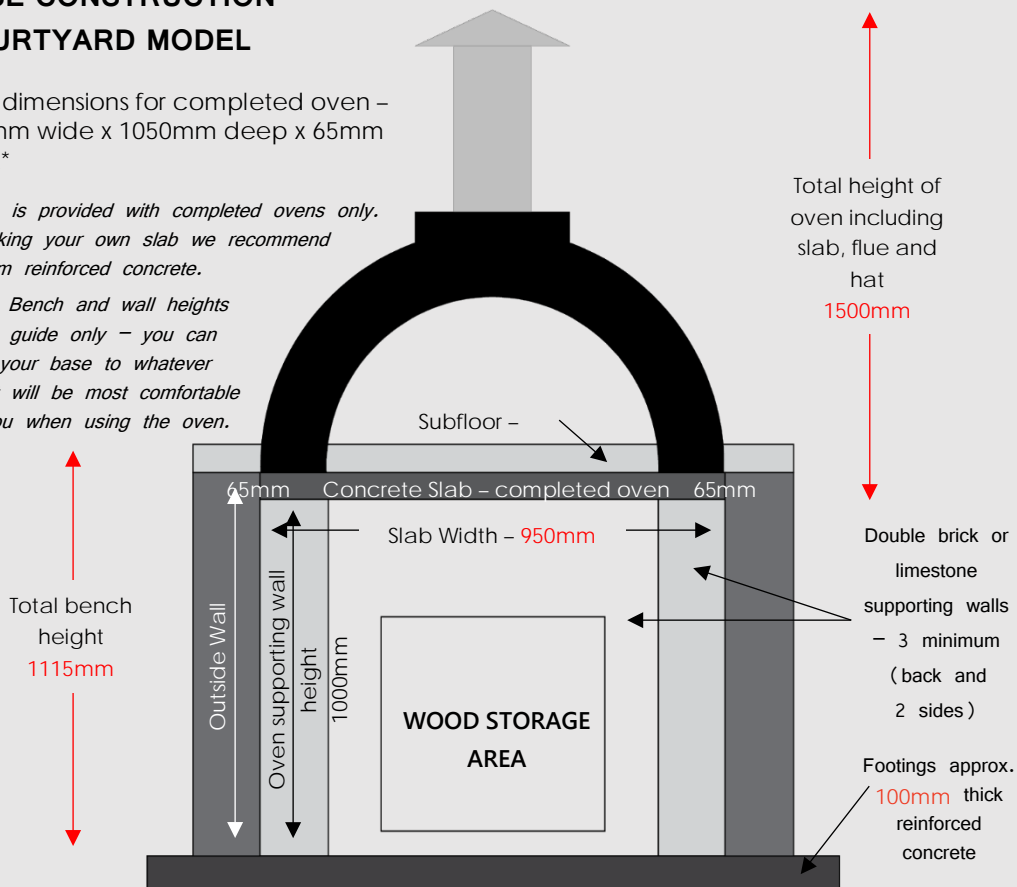

NOTE The aim is to have the benchtop level with the oven floor. Therefore the outside wall should be total bench height less thickness of whatever you are using to finish your benchtop eg. tile thickness.

SPECIFICATIONS – Midi Model

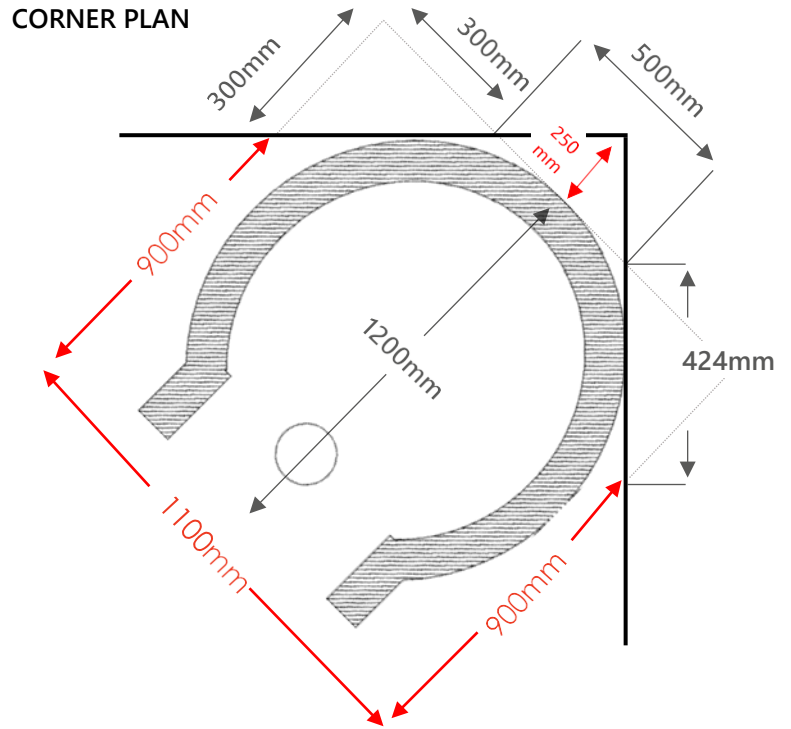
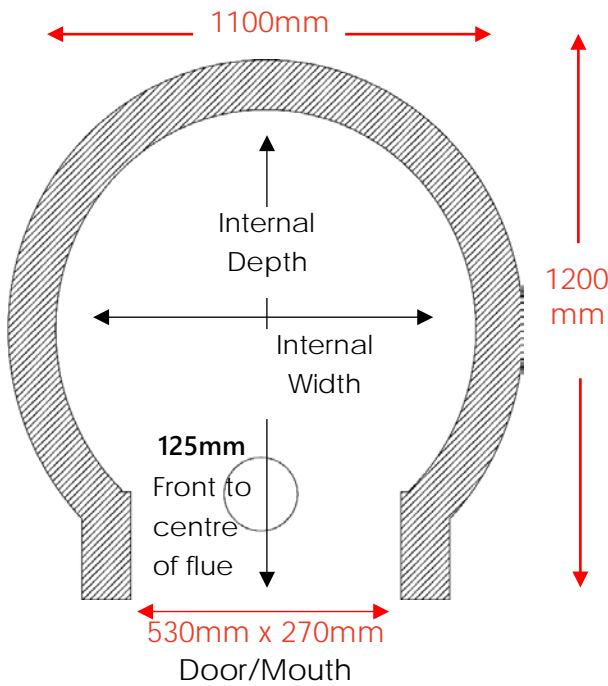

OVEN SPECS OVERVIEW

External Measurements

External width: 1100mm
External depth: 1200mm
External height: ≈ 620mm

Internal Measurements

Internal width: 830mm
Internal depth: 1000mm
Internal height: 440mm

Door/Mouth Measurements

Width: 530mm
Height: 270mm

Stainless Steel Flue Measurements

Length: 1000mm
Diameter: 6" (approx 152mm)

Weight

Completed unit (including slab) ≈ 600kg
DIY kit (no slab) ≈ 450kg

BASE CONSTRUCTION MIDI MODEL

Slab dimensions for completed oven – 1100mm wide x 1200mm deep x 65mm thick*

*Slab is provided with completed ovens only. If making your own slab we recommend 100mm reinforced concrete.

NOTE Bench and wall heights are a guide only – you can build your base to whatever height will be most comfortable for you when using the oven.

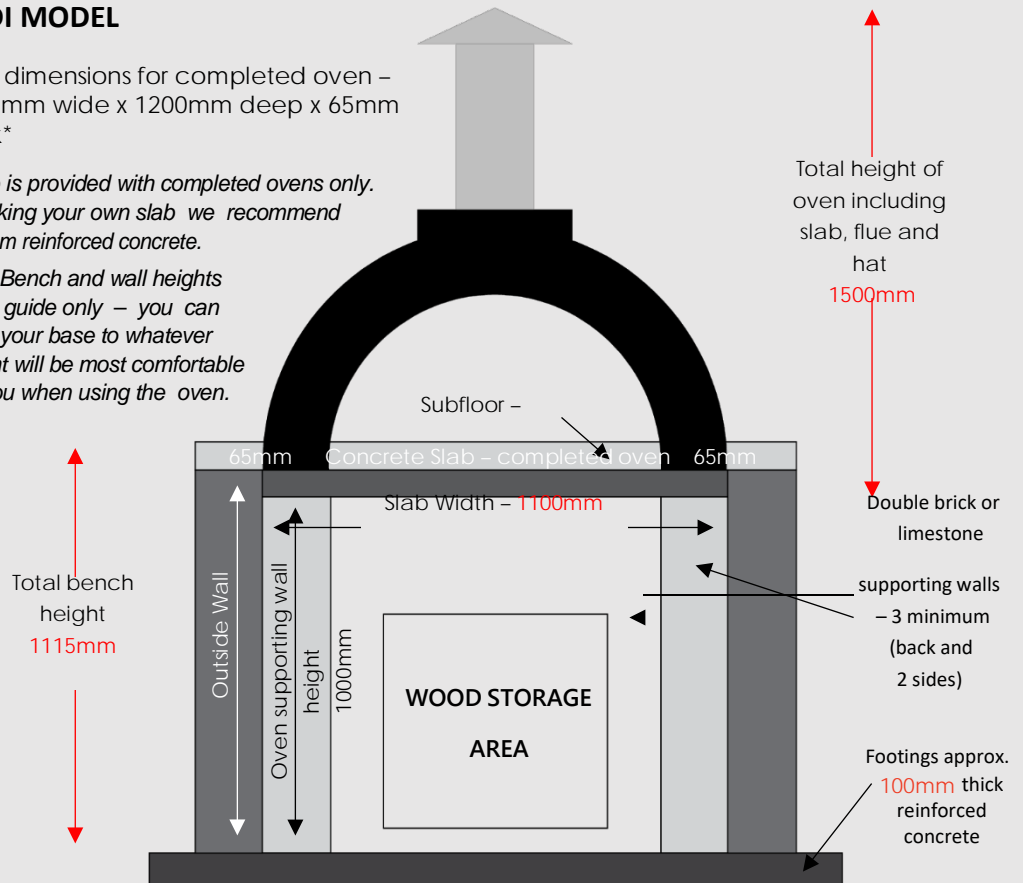

NOTE The aim is to have the bench top level with the oven floor. Therefore the outside wall should be total bench height less thickness of whatever you are using to finish your bench top e.g. tile thickness.

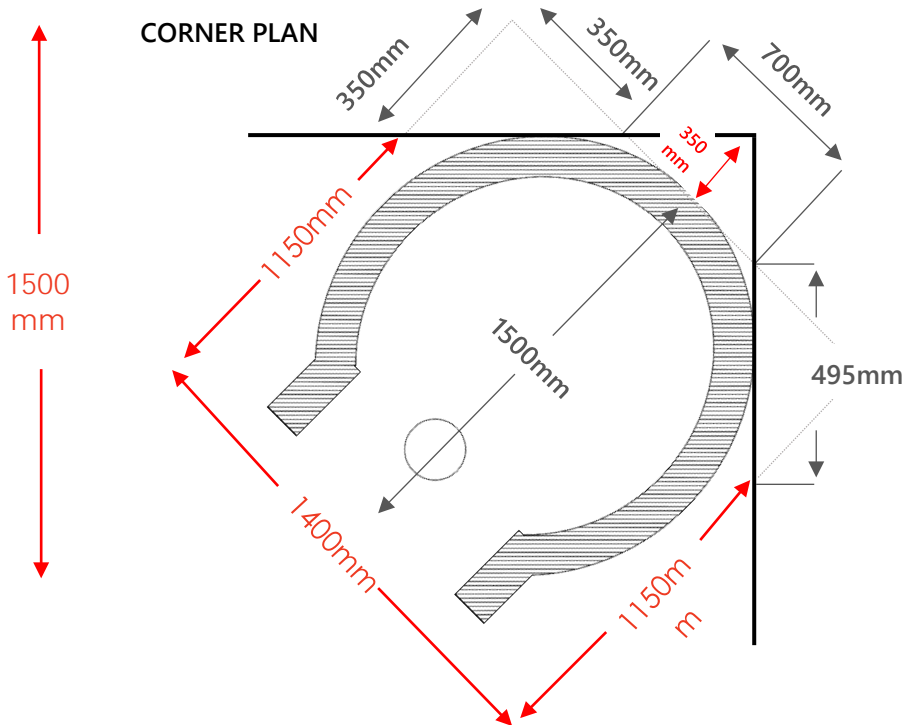
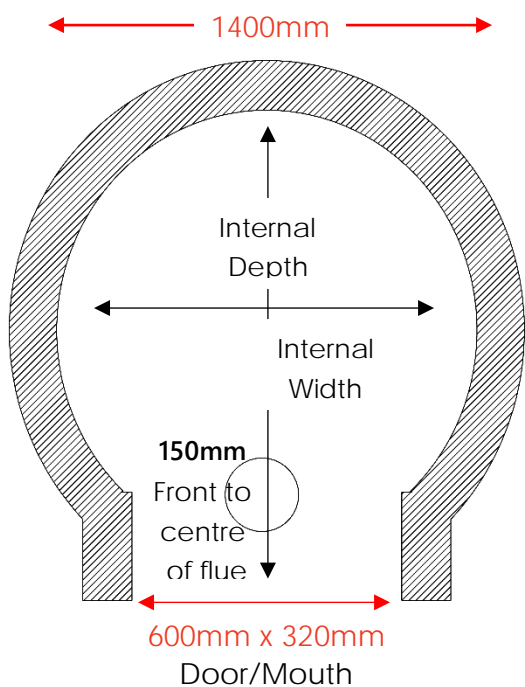

OVEN SPECS OVERVIEW

External Measurements

External width: 1400mm
External depth: 1500mm
External height: ≈700mm

Internal Measurements

Internal width: 1100mm
Internal depth: 1280mm
Internal height: 470mm

Door/Mouth Measurements

Width: 600mm
Height: 320mm

Stainless Steel Flue Measurements

Length: 1000mm
Diameter: 8" (approx 203mm)

Weight

Completed unit (including slab) ≈1100kg
DIY kit (no slab) ≈800kg

BASE CONSTRUCTION ORIGINAL MODEL

Slab dimensions for completed oven – 1400mm wide x 1500mm deep x 65mm thick*

*Slab is provided with completed ovens only. If making your own slab we recommend 100mm reinforced concrete.

NOTE Bench and wall heights are a guide only – you can build your base to whatever height will be most comfortable for you when using the oven.

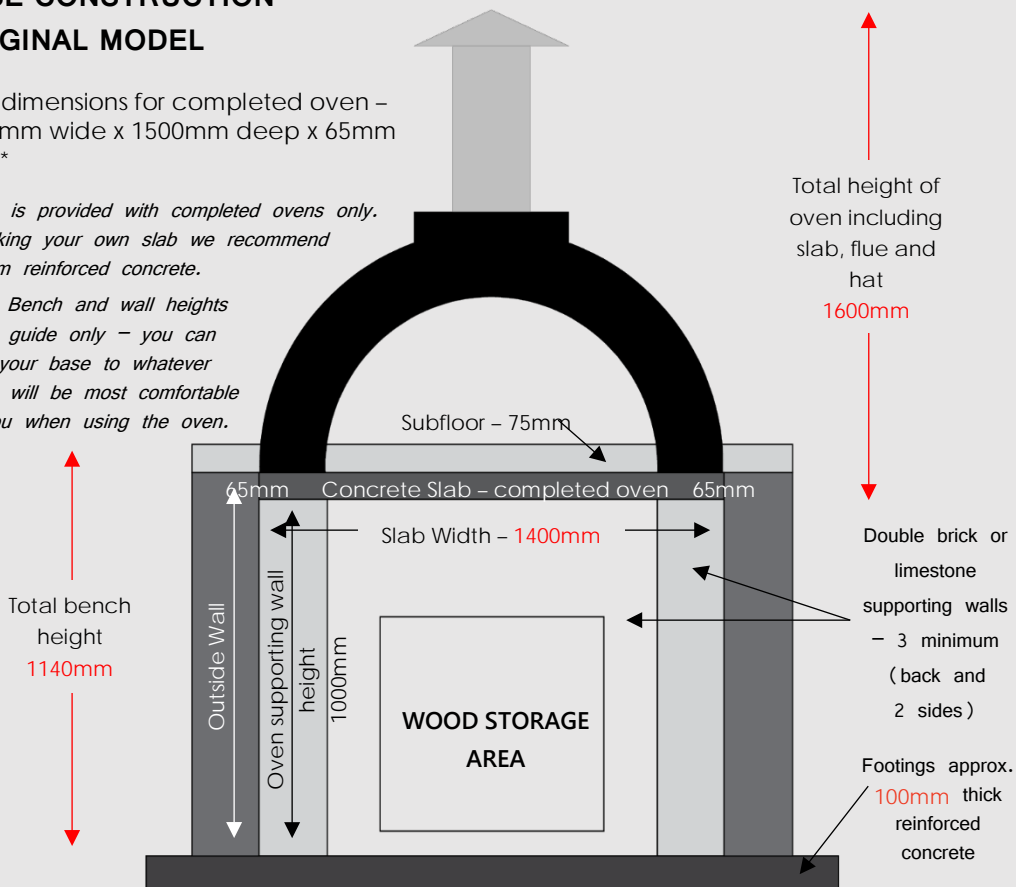

NOTE The aim is to have the benchtop level with the oven floor. Therefore the outside wall should be total bench height less thickness of whatever you are using to finish your benchtop eg. tile thickness.